



Instruction Book for HD8000 and HC8024 Wire Closers



Table of Contents

Topic:	Page Number:
Safety Alert Symbols	3
Safe operating guidelines	3
Proper machine placement	3
HD8000 Setup	4
Book Preparation	4
Select and insert wire	5
Closing height adjustment	6
Closing the wire	7
Wire sizing chart	8
HC8024 Differences	9

Safety Alert Symbols

- ◆ Make sure you read this section very carefully! Learn to recognize these **Safety Alert Symbols**. The HD8000 and HD8024 have been designed to provide a high level of protection to an operator. Follow the guidelines below while installing, operating and maintaining your machine.



CAUTION: Indicates a hazardous situation which, if not avoided, could result in minor or moderate injury. It may also be used without the safety alert symbol as an alternative to "Notice".



WARNING: Indicates a hazardous situation which, if not avoided, could result in death or serious injury.



DANGER: Indicates a hazardous situation which, if not avoided, will result in death or serious injury. This signal word is to be limited to the most extreme situations.



Trip Hazard



Electric Shock



Cutting Hazard



Two Person Lift



Crushing Hazard



Hint or Suggestion

Safe Operating Guidelines

- ◆ Always keep this instruction manual with the machine for reference to safe operating guidelines and correct operation of the machine.
- ◆ Follow all recommended workplace procedures for repetitive activities.

Placing your machine in the proper location:

- ◆ Place the machine on a hard level surface. Ensure the placement of machine allows for ergonomic work flow (separate locations for unpunched books and a punched books).

HD8000 Setup:

The HD8000 comes with the handle attached to the right side of the machine. The handle can be removed and re-attached with the handle facing away from the machine or it can be attached to the left side of the machine to suit operator needs. If the handle is changed from its original position make sure to retighten the handle bolt securely to ensure proper operation of the handle.

The HD8000 has a reversible top closing plate. To reverse the plate, remove the three small knobs (Fig. 2) from the top of the closing bar and remove the plate from underneath.

To install plate, hold plate under the top closing bar and install the three small knobs.



Fig. 1

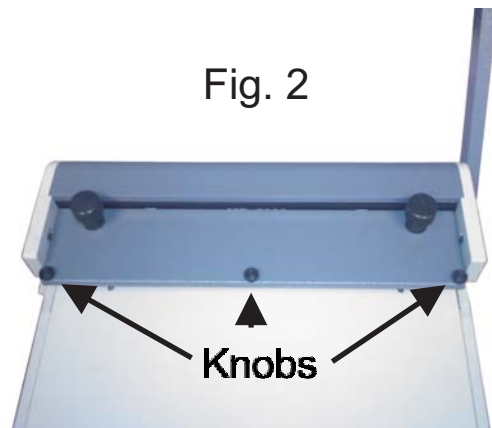

Fig. 2

Book Preparation:

Assemble your punched book completely with covers on the top and bottom if required. Stand the book up with the binding edge toward the left ① and the front of the book facing you.

Pull the rear cover from the back of the book. Flip the page over putting the binding edges back together ②.

Flip the entire book over and place flat with the covers on the bottom ③. This configuration will position the wire binding seam on the inside of the back cover of the book when complete.

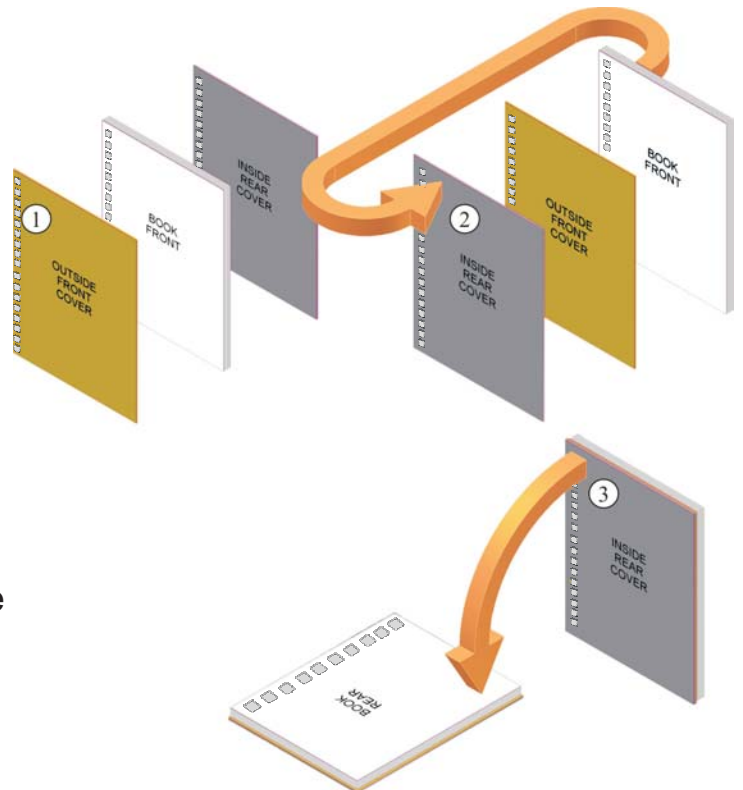

Select Wire:

Refer to chart on page 8 and choose the correct wire size. Insert the narrow wire loop into the book starting from either the left or right side of the book using a slight rotating action.

Rotate the entire wire forward into the book so that the seam of the wire is on top ①. Firmly grab the entire book ② and flip it forward and upside down ③ so the wire faces the closer bar of the machine ④.

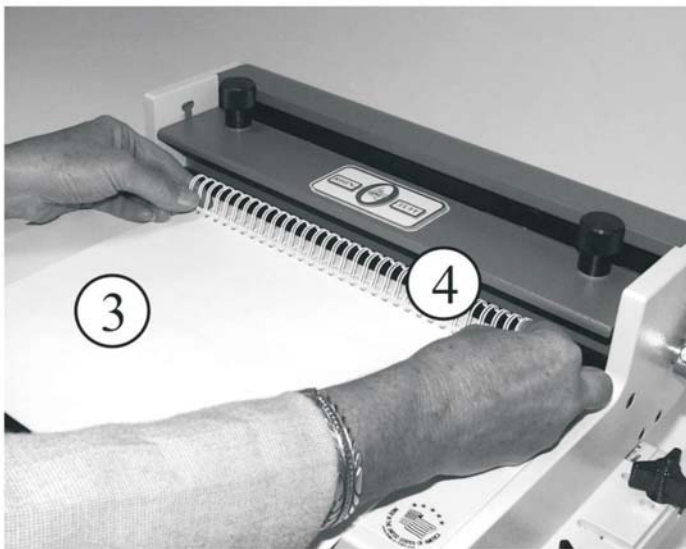

Setting the closer bar height:

The closing bar is adjustable on each end allowing the operator to achieve a uniform close at each end of the book. Pull the handle on the closer all the way down and keep held down as you adjust both knobs ⑤ so the top edge of the closing bar ⑥ lines up on the decal marks ⑦ with the wire size you have chosen.

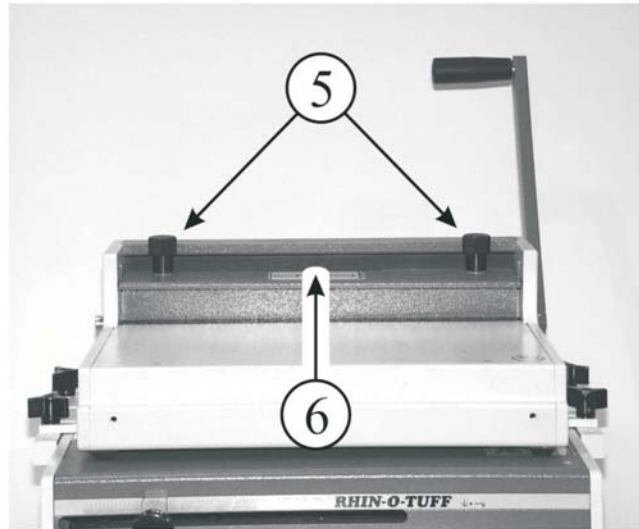

Closing the Wire:

Return handle to the full upright position, place the book so the open mouth of the wire is firmly pressed against the back plate ① inside the closing machine. The narrow, open loop of the wire ② should be be on top of the book while pushing against the back plate ①, with the wire seam on the bottom.

Apply enough pressure on the book so that the wire stays in contact with the back of the machine as you pull the handle down to the position set in the previous section. Return handle to upright position and inspect the close of the wire in your book, re-adjust the closing bar if necessary. When the wire is closed properly, the narrow, open loops overlap the wide loops by about 1/32 inch along the entire length of the book. An indication that the book is not closed correctly is when pages fall out of the book.

Flip the back cover sheet back to the back of the book. Your book is complete.

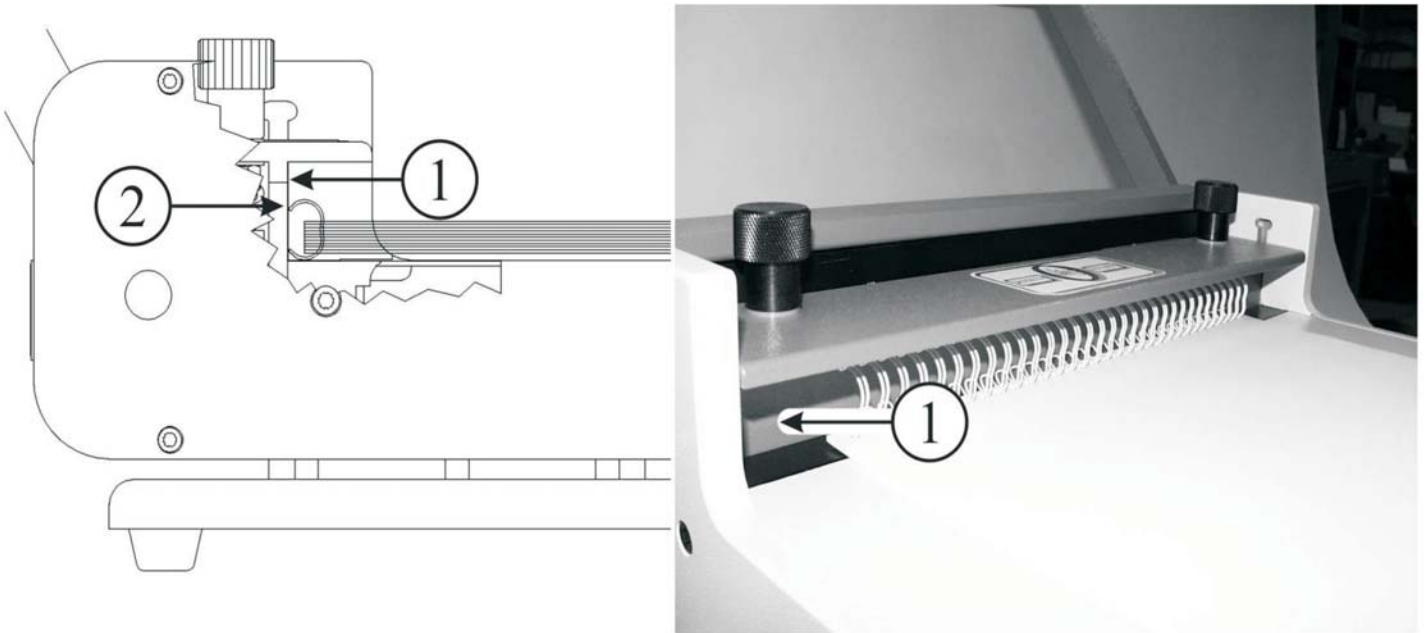

Wire Diameter Diamètre du fil Diámetro del alambre		Book Thickness Épaisseur du Livre Grosor del Libro		Number of Sheets Numéro de Feuilles Número de Hojas	
Inch	MM	Inch	MM	20lb	80gsm
3/16	4.8	1/8	3.2	30	30
¼	6.4	3/16	4.8	45	45
5/16	7.9	¼	6.4	65	65
3/8	9.5	5/16	7.9	80	80
7/16	11.1	3/8	9.5	95	95
½	12.7	7/16	11.1	110	110
9/16	14.3	½	12.7	125	125
5/8	15.9	9/16	14.3	140	140
¾	19	5/8	15.9	160	160
7/8	22.2	¾	19	190	190
1	25.4	7/8	22.2	220	220
1-1/4	31.8	1-1/8	28.6	285	285



Even Close: An even close is the most desirable type of bind.

Under Close: When the narrow loops are closed under the wide loops, the wire forms a wedge, which will keep the covers in the wire from falling out. This is also a desirable bind. The wire still has to be closed tight enough with the closing bar adjustment knobs

Over Close: When the wide loops are closed under the narrow loops, the covers may slip out of the bind if not closed tight enough.

How near the narrow loop is to the wide loop when element is closed. Narrow loop should overlap wide loop by about 1/32" when closed.

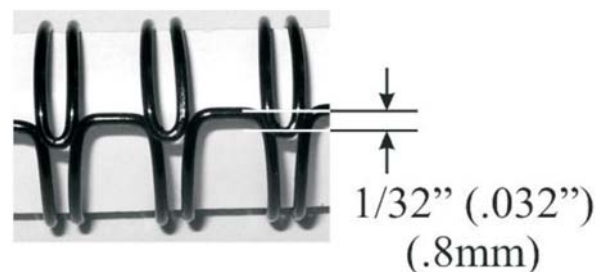

HC8024 Wire closer is 24" long, has two closing handles for ease of use and has an extendable table to help support larger format applications.

Setup of the HC8024 for closing wire follows the same instructions as the HD8000.



If you wish to mount your HD-8000 to your punch machine as shown in the manual, you will need to order Kit "MK-4000" for the 4000 Plus and OD-4012. Or Kit "MK-7000" for the HD-6500, HD-7000 and the HD-7700. Contact your dealer to purchase these kits.

The first thing you will notice after you have unboxed your HD-8000 is a package of threaded rubber feet. These are for use with the HD-8000 in the stand-alone configuration and not used when mounted on a punch. They raise the front of the machine up (see Figure 1) to help the wire rest on the back plate. This will help the closing process. These are an option to use.

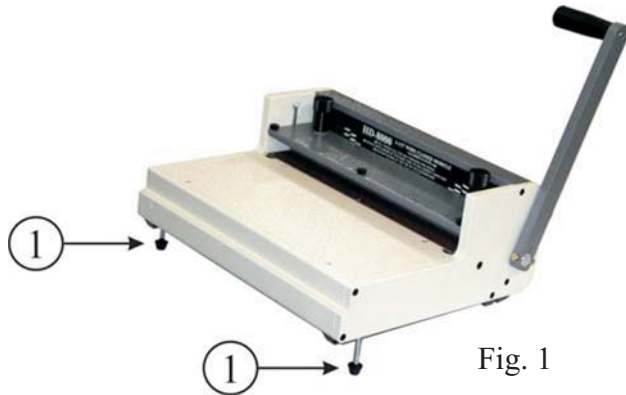

Fig. 1

The HD-8000 comes with a reversible closing plate. This plate is smooth on one side and coarse on the other. Notice in Figure 2, arrow 1 points to a finger screw, there are three of these to be removed to flip over the plate. It is recommended to use the coarse surface facing the wire when binding 1" or greater wire but preferences may vary. The texture keeps the wire from rolling during the closing process.

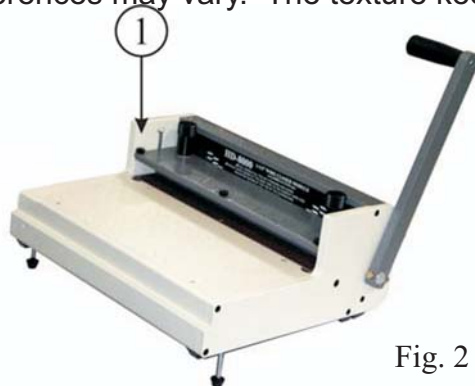

Fig. 2



IMPORTANT

Be sure to fill out and return your Product
Warranty Registration Card or Register online
at:
www.Rhin-O-Tuff.com/warranty_registration.asp

